

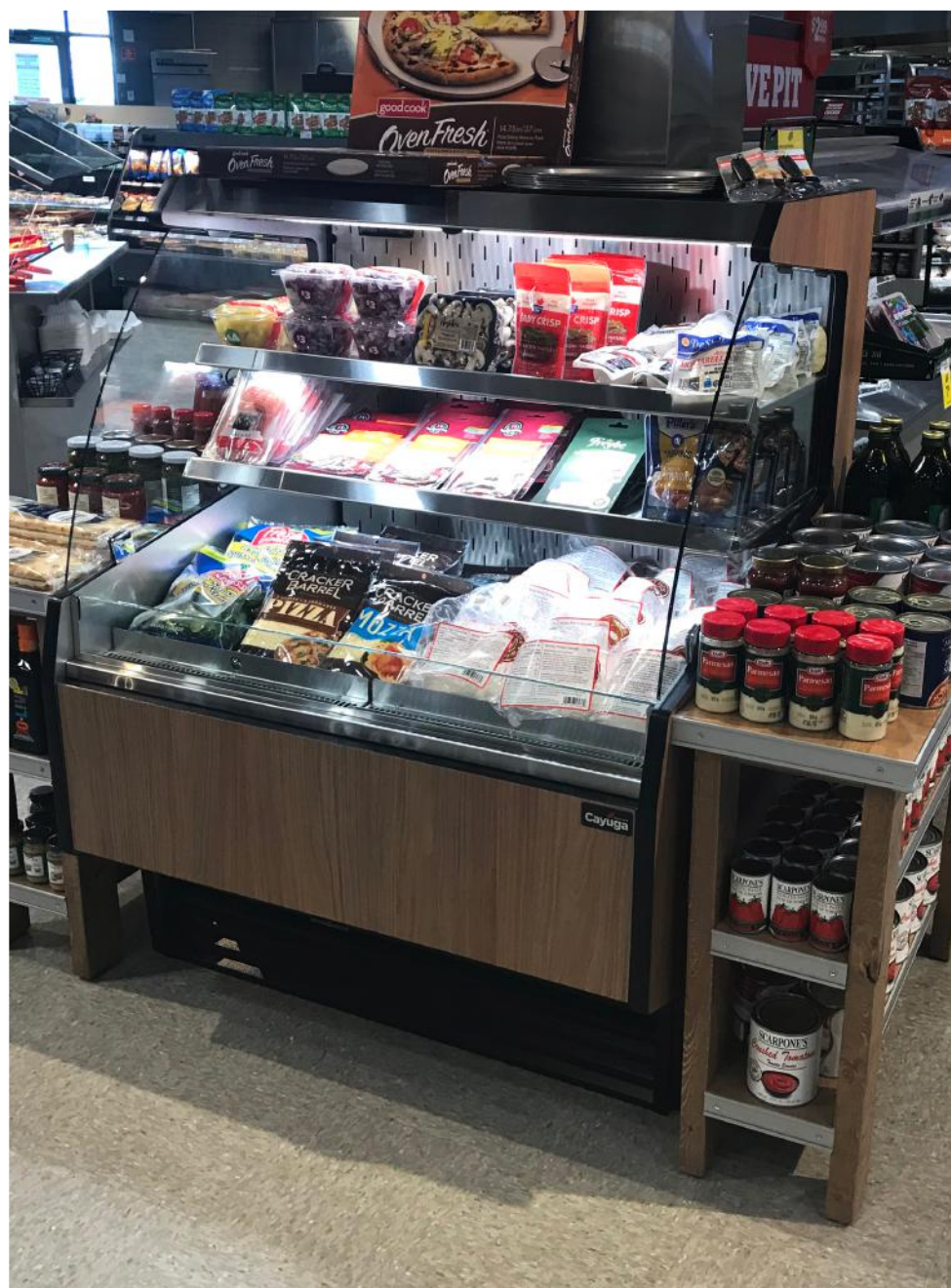

STAND ALONE

COLLECTION

 **DISPLAYS**
Cayuga



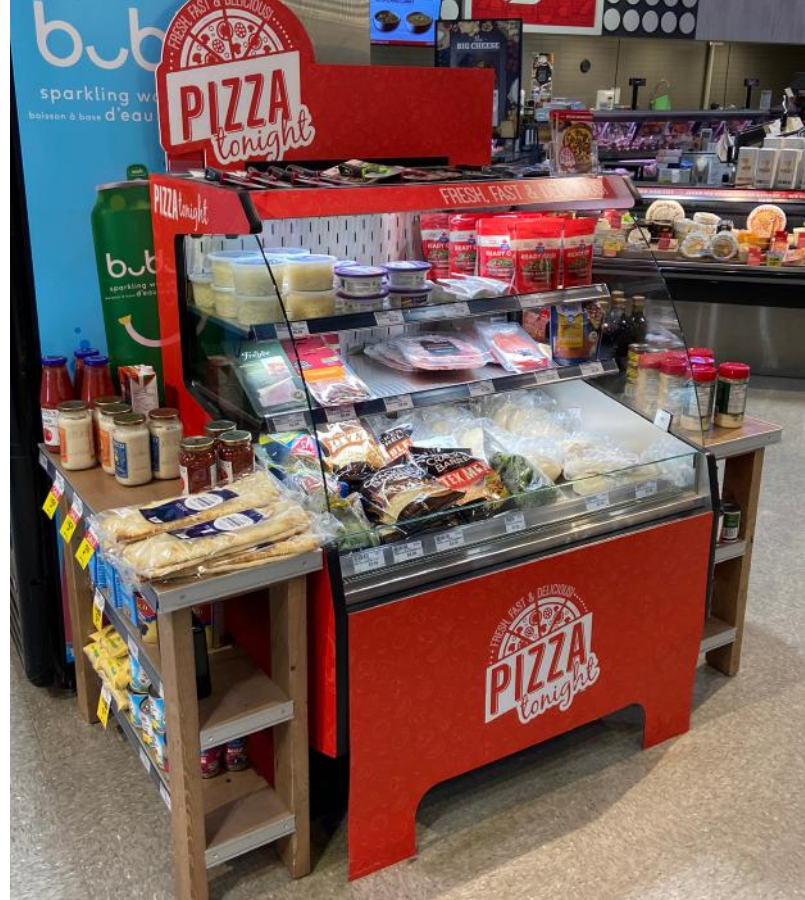



DEPARTMENT:

STAND ALONE

When you add those specialty functions in your retail space you increase sales, but you also enhance the overall brand impression of your store.

Don't let the product - rich center areas or your store go under - utilized. Self-contained plug and play refrigerated displays provide the flexibility to quickly add appealing display options creating visible interest and maximum interest.

Perhaps it's ready to heat prepared food, a meal kit center, or freshly prepared sushi. Let's talk about all of the options. We'll help you find the right unit - or combination of units - to inject excitement and interest on you floor.

We'll help you develop your central zone to achieve the product attention and customer experience that will translate to product sales and customer loyalty!

"Cayuga has always provided us with sensible and reliable options and have always exceeded our expectations in customer service."

Neil Forth,
Neelands Refrigeration
Sales

Table of Contents

Things to Consider	6
Single-Level Self-Service Display - 42”H	8
Single-Level Self-Service Display - 42”H Renderings	10
Two-Level Self-Service Display - 49”H	12
Two-Level Self-Service Display - 49”H Renderings	14
Three-Level Self-Service Display - 54”H	16
Three-Level Self-Service Display - 54”H Renderings	18
Three-Level Upright Self-Service Display - 53”H	20
Three-Level Upright Self-Service Display - 53”H Renderings	22
Four-Level Upright Self-Service Display - 63”H	24
Four-Level Upright Self-Service Display - 63”H Renderings	26
Refrigerated Display Accessories	27
Five-Level Upright Self-Service Display - 76”H	28
Five-Level Upright Self-Service Display - 76”H Renderings	30
Refrigerated Display Accessories	31
Curved Glass Service Display	36
Curved Glass Dry Service Display	38
Square Glass Service Display	40
Square Glass Dry Service Display	42
Self-Contained Front Self-Service Display, Rear Preparation Station & Refrigerated Base Storage Cabinet	44
Self-Contained Front Self-Service Display, Rear Preparation Station & Refrigerated Base Storage Cabinet Renderings	46
Finishes	
Laminate	48
Painted Metal	50
Wood Stains	51
How to Order	52

THINGS TO CONSIDER

Showcases are designed to display your refrigerated products at 38-41°F (4-5°C). Showcases are designed to perform in environments of maximum 75°F (23°C) and 55% relative humidity.

****NOTE: FOR YOUR SHOWCASE TO FUNCTION AT PEAK EFFICIENCY YOU WILL NEED PROPER CLIMATE CONTROL AND AIR CIRCULATION****

You need to consider the following when selecting a showcase and placing it in your store environment:

1 Consider nearby doorways and vestibules



A location near a doorway will negatively affect the airflow and holding temperature of both open and closed showcases.

2 Consider nearby windows



Direct sunlight will negatively affect the holding temperature of both open and closed showcases.

3 Consider nearby vent sources, hoods, cooking equipment and fans



HVAC ceiling vents, exhaust hoods, cooking equipment (steam heat) and ceiling fans will negatively affect the airflow of open showcases and will create condensation on the showcases if not properly managed.

4 Ensure your display is level and plumb



Ensure your showcase is plumb and level to allow for proper drainage of condensation water.

Please note: These are critical points to ensure the best results for your equipment and efficient space – and the best return on your investment!

Regular Maintenance and Cleaning

Your showcase will work at its peak performance with regular maintenance. Refer to the Owner's Manual for maintenance and cleaning instructions.

To access the Owner's manual either visit us at cayugadisplays.com/resources/manuals or access the QR code located on the electrical box of your case. You can also check out our online maintenance video.



Watch our maintenance videos at <https://cayugadisplays.com/resources/videos>

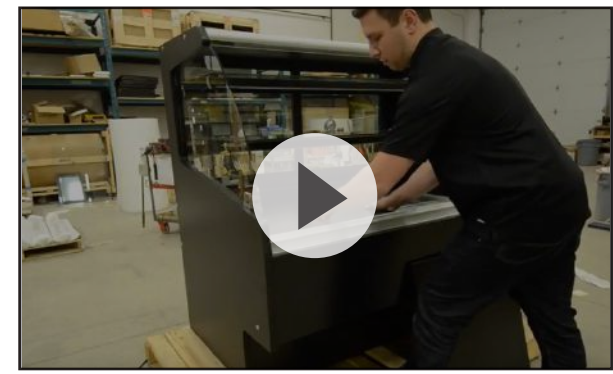

5 Leave appropriate space behind display



A 6" space is required behind any showcase that is against a wall or has a rear obstruction to allow for proper air flow around your showcase.

6 Clean your condenser grill and pre-filter



Use the included brush to regularly wipe away dust. Too much dust will not allow the refrigeration to work properly and could result in **expensive** damage.

****Refer to Owner's Manual for additional case cleaning checklist****

7 ONLY PRE-CHILLED product in case



Refrigerated displays are designed to **KEEP COLD PRODUCT COLD** - they are not designed to bring warm products down to a cold temperature. For food safety it is always imperative that warm product be properly chilled (using a blast chiller or cold room) prior to storing in the refrigerated display case.

8 Noise



Self-contained cases have compressors, motors and fans and these will make noise. Keeping your showcase serviced and clean will help keep the noise level under control, improve lifespan, and maintain efficiency.

9 Condensation on closed and open cases

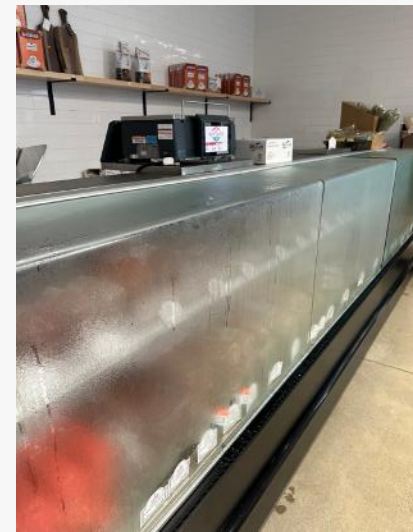

Condensation is caused by warm, moist air coming into contact with cool surfaces. If the case environment is not maintained below 75°F/23°C and 55% relative humidity, condensation may occur.

SINGLE-LEVEL SELF-SERVICE DISPLAY - 42" H

 REFRIGERATED



Standard features shown



Custom options available, refer to options schedule on next page.

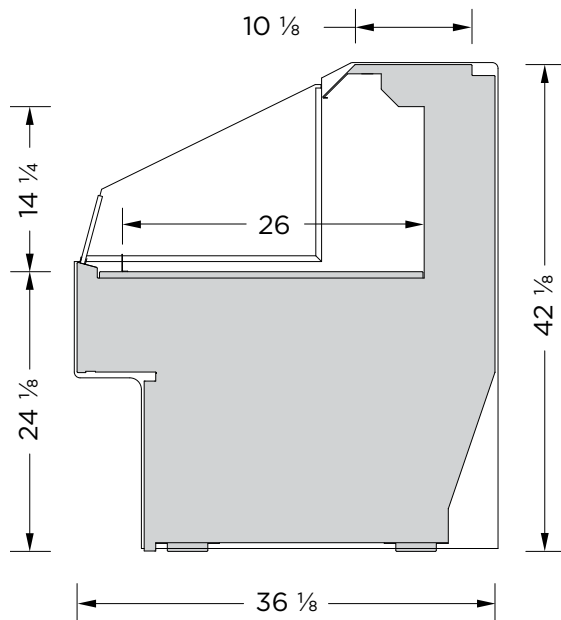

MODEL	LENGTH
MRO-24-42	26 1/4"
MRO-38-42	40 1/4"
MRO-48-42	49 7/8"
MRO-57-42	59 3/8"
MRO-76-42	78 1/2"
MRO-96-42	97 5/8"

FEATURES:

- Brushed Stainless steel internal cabinet construction
- Many exterior finish options available: powdercoat paint, brushed stainless steel, laminates and natural wood finishes
- 3 interior finish options: textured powdercoat black, white and brushed stainless steel
- Other custom options are offered. Refer to the options schedule on the next page
- A LED light strip is mounted on the top ledge of the display area. Various light intensities/spectrums are available
- Designed to maintain the critical temperature of the products within the display at a range of 38-41°F (3-5°C) with an ambient atmosphere of 75°F (24°C)/55% humidity
- ETL electrical certification and NSF-7 standards
- New R-513A (non-ozone depleting, low global warming potential) refrigerant used in the self-contained refrigeration system
- The refrigeration system is designed to pull fresh air from the front base of the display and vent through an integrated rear vent. The unique rear vent allows the display to be backed up against a wall or other displays/obstructions
- Remote refrigeration available. Contact Cayuga Displays for details

SUGGESTED APPLICATIONS:

-  Cafe
-  Restaurant
-  Bakery
-  Butcher Shop
-  Deli
-  Produce

Note: Information and specifications may change due to engineering improvements.



SINGLE-LEVEL SELF-SERVICE DISPLAY - 42" H

REFRIGERATED

TECHNICAL SPECS				
MODEL	LENGTH	VOLTS	AMPS	NEMA PLUG
MRO-24-42	26 ¼"	115	11.8	5-15P
MRO-38-42	40 ¼"	115	11.9	5-15P
MRO-48-42	49 ⅞"	115	12.0	5-15P
MRO-57-42	59 ⅝"	115/230	9.3	L14-20P
MRO-76-42	78 ½"	115/230	12.1	L14-20P
MRO-96-42	97 ⅝"	115/230	12.5	L14-20P

STANDARD FEATURES:

- 3 interior finishes options: textured powdercoat black, white and brushed stainless steel
- Black or white laminate exterior finish
- Solid end panels with black or white interior finish
- A LED light strip is mounted on the top ledge of the display area
- The refrigeration system is designed to pull fresh air from the front base of the display and vent through an integrated rear vent. The unique rear vent allows the display to be backed up against a wall or other displays/obstructions

CUSTOM FEATURES:

EXTERIOR FINISHES	
Formica laminate finish: _____	
Other laminate finish (specify): _____	
Other custom lamiate specs:	
Brushed Stainless Steel	
Oak Veneer Plywood	
- Vertical grain direction	
- Horizontal grain direction	
Birch/Maple Veneer Plywood	
- Vertical grain direction	
- Horizontal grain direction	
Clear finish applied to veneer	
Stain finish Choice: _____	
1" black McCue impact bumper strip applied to the front of the display	
Other McCue impact bumper strip colors available upon request	

END PANELS

Interior laminate the same as exterior	
Brushed Stainless Steel interior	
Mirrored interior	
Tempered glass end panels	
Mirrored glass panels	
1" black McCue impact bumper strip applied to the front of the display	
Other McCue impact bumper strip colors available upon request	

MISCELLANEOUS

2 ½" H x 14"D Stepped riser	
Perforated inlay panel for canted display	
Roll-down thermal night curtain	
Heavy duty lockable casters	
Bolt-on top mounted dry shelving display	

ADDITIONAL FEATURES:

- Designed to maintain the critical temperature of the products within the display at a range of 38-41°F (3-5°C) with an ambient atmosphere of 75°F (24°C)/55% humidity. Designed for holding pre-chilled product only
- Hot gas condensate evaporation system (most units)
- ETL listed and Sanitation certified to NSF-7
- 1 year parts and labor warranty

SINGLE-LEVEL SELF-SERVICE DISPLAY - 42”H

STANDARD FEATURES SHOWN

CUSTOM FEATURES SHOWN

MRO-24-42



FINISHES:
POWDERCOAT,
TEXTURED BLACK



FINISHES:
LAMINATE,
BRAZILWOOD (7946)

MRO-38-42



FINISHES:
POWDERCOAT,
TEXTURED BLACK



FINISHES:
LAMINATE,
SOFT GOLD MESH (4911)

MRO-48-42



FINISHES:
POWDERCOAT,
TEXTURED BLACK



FINISHES:
LAMINATE,
PORT (D14)

SINGLE-LEVEL SELF-SERVICE DISPLAY - 42" H

STANDARD FEATURES SHOWN

CUSTOM FEATURES SHOWN

MRO-57-42



FINISHES:
POWDERCOAT,
TEXTURED BLACK



FINISHES:
LAMINATE,
VAPOR STRANDZ (4939K)

MRO-76-42



FINISHES:
POWDERCOAT,
TEXTURED BLACK



FINISHES:
LAMINATE,
SPROUT (4918)

MRO-96-42



FINISHES:
POWDERCOAT,
TEXTURED BLACK

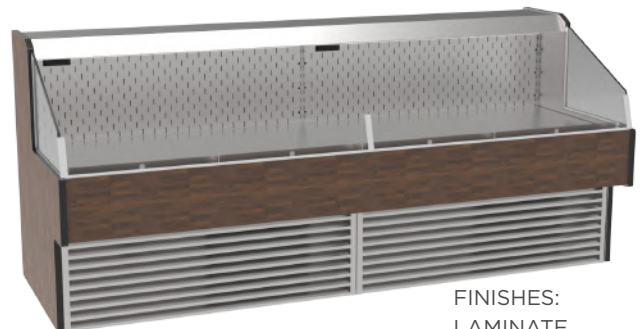

FINISHES:
LAMINATE,
OLD MILL OAK (7973K)

TWO-LEVEL SELF-SERVICE DISPLAY - 49"H

 REFRIGERATED

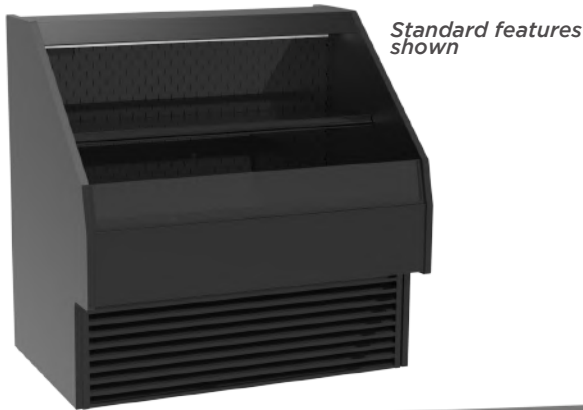

Custom options available, refer to options schedule on next page.

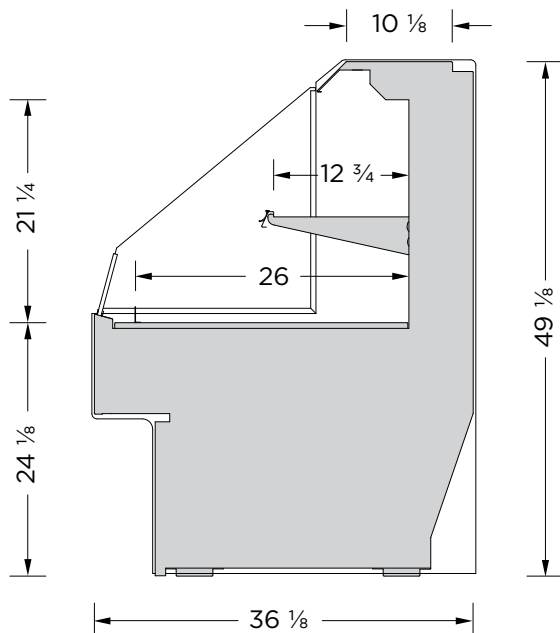

MODEL	LENGTH
MRO-24-49	26 1/4"
MRO-38-49	40 1/4"
MRO-48-49	49 7/8"
MRO-57-49	59 3/8"
MRO-76-49	78 1/2"
MRO-96-49	97 5/8"

FEATURES:

- Brushed Stainless steel internal cabinet construction
- Many exterior finish options available: powdercoat paint, brushed stainless steel, laminates and natural wood finishes
- 3 interior finish options: textured powdercoat black, white and brushed stainless steel
- Other custom options are offered. Refer to the options schedule on the next page
- A LED light strip is mounted on the top ledge of the display area. Various light intensities/spectrums are available
- 1-12" adjustable metal shelf with integrated front product stop and LED light strip mounted to the bottom of the shelf
- Designed to maintain the critical temperature of the products within the display at a range of 38-41°F (3-5°C) with an ambient atmosphere of 75°F (24°C)/55% humidity
- ETL electrical certification and NSF-7 standards
- New R-513A (non-ozone depleting, low global warming potential) refrigerant used in the self-contained refrigeration system
- The refrigeration system is designed to pull fresh air from the front base of the display and vent through an integrated rear vent. The unique rear vent allows the display to be backed up against a wall or other displays/obstructions
- Remote refrigeration available. Contact Cayuga Displays for detail

SUGGESTED APPLICATIONS:

-  Cafe
-  Restaurant
-  Bakery
-  Butcher Shop
-  Deli
-  Produce

Note: Information and specifications may change due to engineering improvements.



TWO-LEVEL SELF-SERVICE DISPLAY - 49”H

REFRIGERATED

TECHNICAL SPECS				
MODEL	LENGTH	VOLTS	AMPS	NEMA PLUG
MRO-24-49	26 ¼”	115	11.8	5-15P
MRO-38-49	40 ¼”	115	11.9	5-15P
MRO-48-49	49 ⅞”	115	12.0	5-15P
MRO-57-49	59 ⅜”	115/230	9.3	L14-20P
MRO-76-49	78 ½”	115/230	12.1	L14-20P
MRO-96-49	97 ⅝”	115/230	12.5	L14-20P

STANDARD FEATURES:

- 3 interior finishes options: textured powdercoat black, white and brushed stainless steel
- Black or white laminate exterior finish
- Solid end panels with black or white interior finish
- A LED light strip is mounted on the top ledge of the display area
- 1-12” adjustable metal shelf with integrated front product stop and LED light strip mounted to the bottom of the shelf
- The refrigeration system is designed to pull fresh air from the front base of the display and vent through an integrated rear vent. The unique rear vent allows the display to be backed up against a wall or other displays/obstructions

CUSTOM FEATURES:

EXTERIOR FINISHES	
Formica laminate finish: _____	
Other laminate finish (specify): _____	
Other custom lamiante specs:	
Brushed Stainless Steel	
Oak Veneer Plywood	
- Vertical grain direction	
- Horizontal grain direction	
Birch/Maple Veneer Plywood	
- Vertical grain direction	
- Horizontal grain direction	
Clear finish applied to veneer	
Stain finish Choice: _____	
1” black McCue impact bumper strip applied to the front of the display	
Other McCue impact bumper strip colors available upon request	

END PANELS

Interior laminate the same as exterior	
Brushed Stainless Steel interior	
Mirrored interior	
Tempered glass end panels	
Mirrored glass panels	
1” black McCue impact bumper strip applied to the front of the display	
Other McCue impact bumper strip colors available upon request	

MISCELLANEOUS

2 ½” H x 14”D Stepped riser	
Perforated inlay panel for canted display	
Price tag moulding attached to shelf	
Heavy duty lockable casters	
Bolt-on top mounted dry shelving display	

ADDITIONAL FEATURES:

- Designed to maintain the critical temperature of the products within the display at a range of 38-41°F (3-5°C) with an ambient atmosphere of 75°F (24°C)/55% humidity. Designed for holding pre-chilled product only
- Hot gas condensate evaporation system (most units)
- ETL listed and Sanitation certified to NSF-7
- 1 year parts and labor warranty

TWO-LEVEL SELF-SERVICE DISPLAY - 49”H

STANDARD FEATURES SHOWN

CUSTOM FEATURES SHOWN

MRO-24-49



FINISHES:
POWDERCOAT,
TEXTURED BLACK



FINISHES:
LAMINATE,
BRAZILWOOD (7946)

MRO-38-49



FINISHES:
POWDERCOAT,
TEXTURED BLACK



FINISHES:
LAMINATE,
SOFT GOLD MESH (4911)

MRO-48-49



FINISHES:
POWDERCOAT,
TEXTURED BLACK



FINISHES:
LAMINATE,
PORT (D14)

TWO-LEVEL SELF-SERVICE DISPLAY - 49”H

STANDARD FEATURES SHOWN

MRO-57-49



FINISHES:
POWDERCOAT,
TEXTURED BLACK

CUSTOM FEATURES SHOWN



FINISHES:
LAMINATE,
VAPOR STRANDZ (4939K)

MRO-76-49



FINISHES:
POWDERCOAT,
TEXTURED BLACK



FINISHES:
LAMINATE,
SPROUT (4918)

MRO-96-49



FINISHES:
POWDERCOAT,
TEXTURED BLACK



FINISHES:
LAMINATE,
OLD MILL OAK (7973K)

THREE-LEVEL SELF-SERVICE DISPLAY - 54"H

 REFRIGERATED

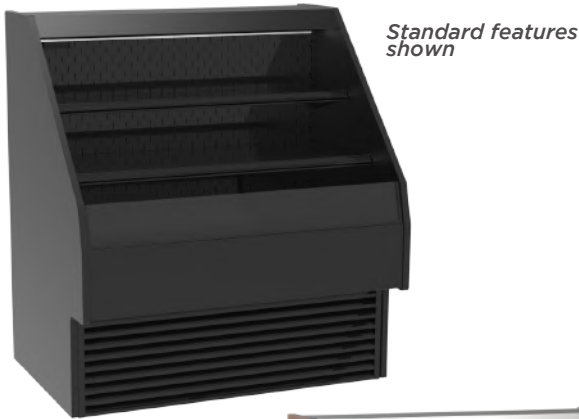

Custom options available, refer to options schedule on next page.

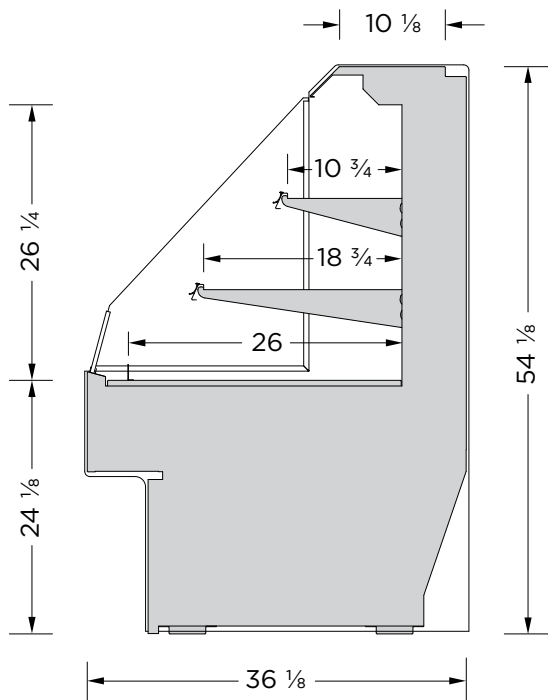

MODEL	LENGTH
MRO-24-54	26 1/4"
MRO-38-54	40 1/4"
MRO-48-54	49 7/8"
MRO-57-54	59 3/8"
MRO-76-54	78 1/2"
MRO-96-54	97 5/8"

FEATURES:

- Brushed Stainless steel internal cabinet construction
- Many exterior finish options available: powdercoat paint, brushed stainless steel, laminates and natural wood finishes
- 3 interior finish options: textured powdercoat black, white and brushed stainless steel
- Other custom options are offered. Refer to the options schedule on the next page
- A LED light strip is mounted on the top ledge of the display area. Various light intensities/spectrums are available
- 1-12" & 1-18" adjustable metal shelves with integrated front product stop and LED light strip mounted to the bottom of the shelves
- Designed to maintain the critical temperature of the products within the display at a range of 38- 41°F (3-5°C) with an ambient atmosphere of 75°F (24°C)/55% humidity
- ETL electrical certification and NSF-7 standards
- New R-513A (non-ozone depleting, low global warming potential) refrigerant used in the self-contained refrigeration system
- The refrigeration system is designed to pull fresh air from the front base of the display and vent through an integrated rear vent. The unique rear vent allows the display to be backed up against a wall or other displays/obstructions
- Remote refrigeration available. Contact Cayuga Displays for details

SUGGESTED APPLICATIONS:

-  Cafe
-  Restaurant
-  Bakery
-  Butcher Shop
-  Deli
-  Produce

Note: Information and specifications may change due to engineering improvements.



THREE-LEVEL SELF-SERVICE DISPLAY - 54" H

 REFRIGERATED

TECHNICAL SPECS				
MODEL	LENGTH	VOLTS	AMPS	NEMA PLUG
MRO-24-54	26 ¼"	115	11.8	5-15P
MRO-38-54	40 ¼"	115	11.9	5-15P
MRO-48-54	49 ⅞"	115	12.0	5-15P
MRO-57-54	59 ⅜"	115/230	9.8	L14-20P
MRO-76-54	78 ½"	115/230	12.6	L14-20P
MRO-96-54	97 ⅝"	115/230	13.0	L14-20P

STANDARD FEATURES:

- 3 interior finishes options: textured powdercoat black, white and brushed stainless steel
- Black or white laminate exterior finish
- Solid end panels with black or white interior finish
- A LED light strip is mounted on the top ledge of the display area
- 1-12" & 1-18" adjustable metal shelves with integrated front product stop and LED light strip mounted to the bottom of the shelves
- The refrigeration system is designed to pull fresh air from the front base of the display and vent through an integrated rear vent. The unique rear vent allows the display to be backed up against a wall or other displays/obstructions

CUSTOM FEATURES:

EXTERIOR FINISHES	
Formica laminate finish: _____	
Other laminate finish (specify): _____	
Other custom lamiantie specs:	
Brushed Stainless Steel	
Oak Veneer Plywood	
- Vertical grain direction	
- Horizontal grain direction	
Birch/Maple Veneer Plywood	
- Vertical grain direction	
- Horizontal grain direction	
Clear finish applied to veneer	
Stain finish Choice: _____	
1" black McCue impact bumper strip applied to the front of the display	
Other McCue impact bumper strip colors available upon request	

END PANELS

Interior laminate the same as exterior	
Brushed Stainless Steel interior	
Mirrored interior	
Tempered glass end panels	
Mirrored glass panels	
1" black McCue impact bumper strip applied to the front of the display	
Other McCue impact bumper strip colors available upon request	

MISCELLANEOUS

2 ½" H x 14"D Stepped riser	
Perforated inlay panel for canted display	
Price tag moulding attached to shelf	
Heavy duty lockable casters	
Bolt-on top mounted dry shelving display	

ADDITIONAL FEATURES:

- Designed to maintain the critical temperature of the products within the display at a range of 38-41°F (3-5°C) with an ambient atmosphere of 75°F (24°C)/55% humidity. Designed for holding pre-chilled product only
- Hot gas condensate evaporation system (most units)
- ETL listed and Sanitation certified to NSF-7
- 1 year parts and labor warranty

TITLE

STANDARD FEATURES SHOWN

CUSTOM FEATURES SHOWN

MRO-24-54



FINISHES:
POWDERCOAT,
TEXTURED BLACK



FINISHES:
LAMINATE,
BRAZILWOOD (7946)

MRO-38-54



FINISHES:
POWDERCOAT,
TEXTURED BLACK



FINISHES:
LAMINATE,
SOFT GOLD MESH (4911)

MRO-48-54



FINISHES:
POWDERCOAT,
TEXTURED BLACK



FINISHES:
LAMINATE,
PORT (D14)

STANDARD FEATURES SHOWN

CUSTOM FEATURES SHOWN

MRO-57-54



FINISHES:
POWDERCOAT,
TEXTURED BLACK



FINISHES:
LAMINATE,
VAPOR STRANDZ (4939K)

MRO-76-54



FINISHES:
POWDERCOAT,
TEXTURED BLACK

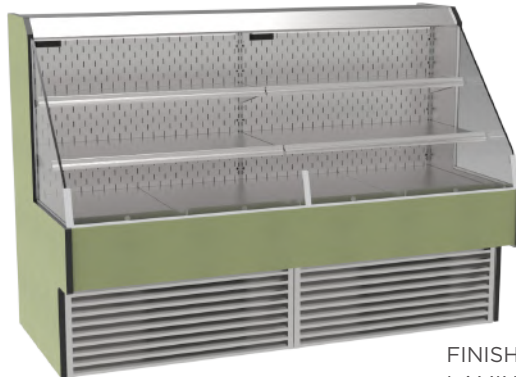

FINISHES:
LAMINATE,
SPROUT (4918)

MRO-96-54



FINISHES:
POWDERCOAT,
TEXTURED BLACK

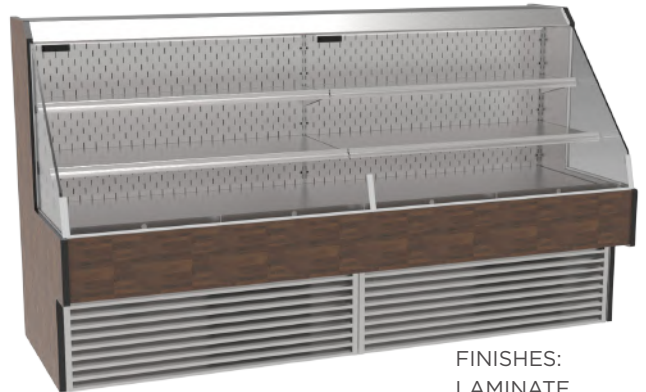

FINISHES:
LAMINATE,
OLD MILL OAK (7973K)

THREE-LEVEL UPRIGHT SELF-SERVICE DISPLAY - 53”H

 REFRIGERATED



Standard features shown



Custom options available, refer to options schedule on next page.

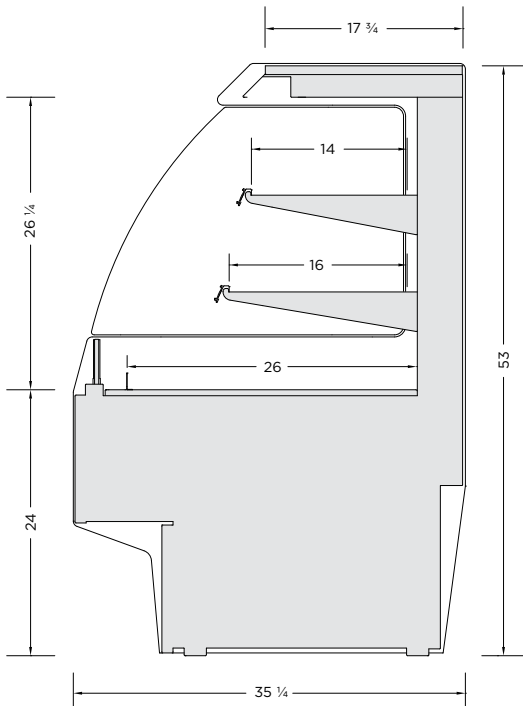

MODEL	LENGTH
MD3M-24-53	26"
MD3M-38-53	40 1/4"
MD3M-48-53	49 7/8"
MD3M-57-53	59 3/8"
MD3M-76-53	78 1/2"
MD3M-96-53	97 5/8"

FEATURES:

- Many exterior finish options available: powdercoat paint, brushed stainless steel, laminates and natural wood finishes
- 3 interior finish options: textured powdercoat black, white and brushed stainless steel
- Other custom options are offered. Refer to the options schedule on the next page
- A LED light strip is mounted on the top ledge of the display area.
- 1-14" and 1-16" adjustable metal shelves with integrated LED lighting.
- The LED lighting is available in various light intensities/spectrums
- Designed to maintain the critical temperature of the products within the display at a range of 38-41°F (3-5°C) with an ambient atmosphere of 75°F (24°C)/55% humidity
- ETL electrical certification and NSF 7 standards
- New R-513A (non-ozone depleting, low global warming potential) refrigerant used in the self-contained refrigeration system
- The refrigeration system is designed to pull fresh air and heated exhaust air through a front vent integrated in the base of the display
- Remote refrigeration available. Contact Cayuga Displays for details

SUGGESTED APPLICATIONS:

-  Cafe
-  Restaurant
-  Bakery
-  Butcher Shop
-  Deli
-  Produce

Note: Information and specifications may change due to engineering improvements.



THREE-LEVEL UPRIGHT SELF-SERVICE DISPLAY - 53”H

 REFRIGERATED

TECHNICAL SPECS				
MODEL	LENGTH	VOLTS	AMPS	NEMA PLUG
MD3M-24-53	26”	115	11.7	5-15P
MD3M-38-53	40 ¼”	115	11.7	5-15P
MD3M-48-53	49 ⅞”	115	11.7	5-15P
MD3M-57-53	59 ⅝”	115/230	8.7	L14-20P
MD3M-76-53	78 ½”	115/230	12.4	L14-20P
MD3M-96-53	97 ⅝”	115/230	12.4	L14-20P

STANDARD FEATURES:

- 3 interior finish options: textured powdercoat black, white and brushed stainless steel
- Black or white laminate exterior finish
- Solid End Panels with black or white interior finish
- A LED light strip is mounted on the top ledge of the display area
- 1-14” and 1-16” adjustable metal shelves with integrated LED lighting
- The refrigeration system is designed to pull fresh air and heated exhaust air through a front vent integrated in the base of the display

CUSTOM FEATURES:

EXTERIOR FINISHES	
Formica laminate finish: _____	
Other laminate finish (specify): _____	
Customer laminate choices	
Brushed Stainless Steel	
Oak Veneer Plywood	
- Vertical grain direction	
- Horizontal grain direction	
Birch/Maple Veneer Plywood	
- Vertical grain direction	
- Horizontal grain direction	
Clear finish applied to veneer	
Stain finish Choice: _____	
1” black McCue impact bumper strip applied to the front of the display	
Other McCue impact bumper strip colors available upon request	

END PANELS

Interior laminate the same as exterior	
Brushed Stainless Steel interior	
Mirrored interior	
Tempered glass end panels	
Mirrored glass panels	
1” black McCue impact bumper strip applied to the front of the display	
Other McCue impact bumper strip colors available upon request	

MISCELLANEOUS

Additional shelf with integrated LED lighting	
Tempered glass shelves with integrated LED lighting	
Roll-down thermal night curtain	
Heavy duty lockable casters	

ADDITIONAL FEATURES:

- Designed to maintain the critical temperature of the products within the display at a range of 38-41°F (3-5°C) with an ambient atmosphere of 75°F (24°C)/55% humidity. Designed for holding pre-chilled product only
- Hot gas condensate evaporation system (most units)
- ETL listed and Sanitation certified to NSF-7
- 1 year parts and labor warranty

THREE-LEVEL UPRIGHT SELF-SERVICE DISPLAY - 53”H

STANDARD FEATURES SHOWN

CUSTOM FEATURES SHOWN

MD3M-24-53



FINISHES:
POWDERCOAT,
TEXTURED BLACK



FINISHES:
LAMINATE,
BRAZILWOOD (7946)

MD3M-38-53



FINISHES:
POWDERCOAT,
TEXTURED BLACK



FINISHES:
LAMINATE,
SOFT GOLD MESH (4911)

MD3M-48-53



FINISHES:
POWDERCOAT,
TEXTURED BLACK



FINISHES:
LAMINATE,
WINDSWEPT BRONZE (4795)

THREE-LEVEL UPRIGHT SELF-SERVICE DISPLAY - 53”H

STANDARD FEATURES SHOWN

CUSTOM FEATURES SHOWN

MD3M-57-53



FINISHES:
POWDERCOAT,
TEXTURED BLACK



FINISHES:
LAMINATE,
VAPOR STRANDZ (4939K)

MD3M-76-53



FINISHES:
POWDERCOAT,
TEXTURED BLACK



FINISHES:
LAMINATE,
SPROUT (4918)

MD3M-96-53

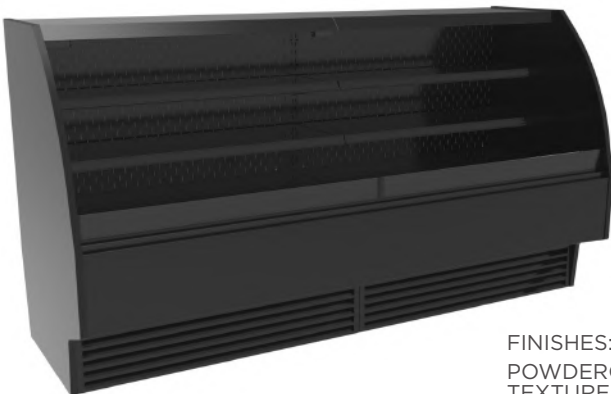

FINISHES:
POWDERCOAT,
TEXTURED BLACK



FINISHES:
LAMINATE,
OLD MILL OAK (7973K)

FOUR-LEVEL UPRIGHT SELF-SERVICE DISPLAY - 63"H

 REFRIGERATED



Standard features shown



Custom options available, refer to options schedule on next page.

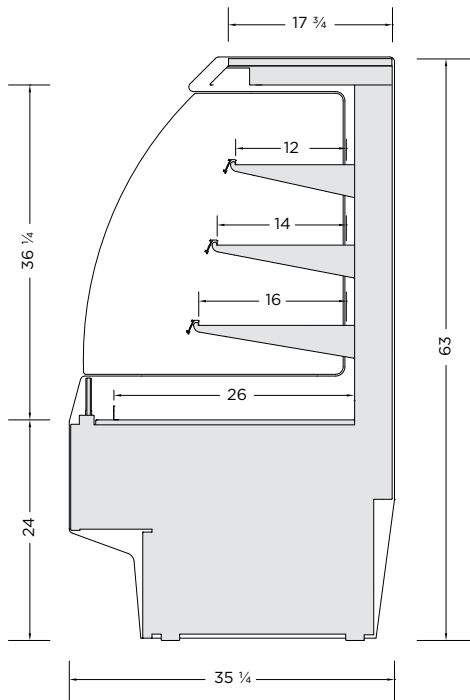

MODEL	LENGTH
MD4M-24-63	26"
MD4M-38-63	40 1/4"
MD4M-48-63	49 7/8"
MD4M-57-63	59 3/8"
MD4M-76-63	78 1/2"
MD4M-96-63	97 5/8"

FEATURES:

- Many exterior finish options available: powdercoat paint, brushed stainless steel, laminates and natural wood finishes
- 3 interior finish options: textured powdercoat black, white and brushed stainless steel
- Other custom options are offered. Refer to the options schedule on the next page
- A LED light strip is mounted on the top ledge of the display area.
- 1-12", 1-14" and 1-16" adjustable metal shelves with integrated LED lighting.
- The LED lighting is available in various light intensities/spectrums
- Designed to maintain the critical temperature of the products within the display at a range of 38- 41°F (3-5°C) with an ambient atmosphere of 75°F (24°C)/55% humidity
- ETL electrical certification and NSF 7 standards
- New R-513A (non-ozone depleting, low global warming potential) refrigerant used in the self-contained refrigeration system
- The refrigeration system is designed to pull fresh air and heated exhaust air through a front vent integrated in the base of the display
- Remote refrigeration available. Contact Cayuga Displays for details

SUGGESTED APPLICATIONS:

-  Cafe
-  Restaurant
-  Bakery
-  Butcher Shop
-  Deli
-  Produce

Note: Information and specifications may change due to engineering improvements.



FOUR-LEVEL UPRIGHT SELF-SERVICE DISPLAY - 63”H

 REFRIGERATED

TECHNICAL SPECS				
MODEL	LENGTH	VOLTS	AMPS	NEMA PLUG
MD4M-24-63	26”	115	11.7	5-15P
MD4M-38-63	40 ¼”	115	11.7	5-15P
MD4M-48-63	49 ⅞”	115	11.7	5-15P
MD4M-57-63	59 ⅝”	115/230	8.7	L14-20P
MD4M-76-63	78 ½”	115/230	12.4	L14-20P
MD4M-96-63	97 ⅝”	115/230	12.4	L14-20P

STANDARD FEATURES:

- 3 interior finish options: textured powdercoat black, white and brushed stainless steel
- Black or white laminate exterior finish
- Solid End Panels with black or white interior finish
- A LED light strip is mounted on the top ledge of the display area
- 1-12”, 1-14” and 1-16” adjustable metal shelves with integrated LED lighting
- The refrigeration system is designed to pull fresh air and heated exhaust air through a front vent integrated in the base of the display

CUSTOM FEATURES:

EXTERIOR FINISHES	
Formica laminate finish: _____	
Other laminate finish (specify): _____	
Customer laminate choices	
Brushed Stainless Steel	
Oak Veneer Plywood	
- Vertical grain direction	
- Horizontal grain direction	
Birch/Maple Veneer Plywood	
- Vertical grain direction	
- Horizontal grain direction	
Clear finish applied to veneer	
Stain finish Choice: _____	
1” black McCue impact bumper strip applied to the front of the display	
Other McCue impact bumper strip colors available upon request	

END PANELS

Interior laminate the same as exterior	
Brushed Stainless Steel interior	
Mirrored interior	
Tempered glass end panels	
Mirrored glass panels	
1” black McCue impact bumper strip applied to the front of the display	
Other McCue impact bumper strip colors available upon request	

MISCELLANEOUS

Additional shelf with integrated LED lighting	
Tempered glass shelves with integrated LED lighting	
Roll-down thermal night curtain	
Heavy duty lockable casters	

ADDITIONAL FEATURES:

- Designed to maintain the critical temperature of the products within the display at a range of 38-41°F (3-5°C) with an ambient atmosphere of 75° (24°C)/55% humidity. Designed for holding pre-chilled product only
- Hot gas condensate evaporation system (most units)
- ETL listed and sanitation certified to NSF 7
- 1 year parts and labor warranty

FOUR-LEVEL UPRIGHT SELF-SERVICE DISPLAY - 63”H

STANDARD FEATURES SHOWN

CUSTOM FEATURES SHOWN

MD4M-24-63



FINISHES:
POWDERCOAT,
TEXTURED BLACK



FINISHES:
LAMINATE,
BRAZILWOOD (7946)

MD4M-38-63



FINISHES:
POWDERCOAT,
TEXTURED BLACK



FINISHES:
LAMINATE,
SOFT GOLD MESH (4911)

MD4M-48-63



FINISHES:
POWDERCOAT,
TEXTURED BLACK



FINISHES:
LAMINATE,
WINDSWEPT BRONZE (4795)

FOUR-LEVEL UPRIGHT SELF-SERVICE DISPLAY - 63”H

STANDARD FEATURES SHOWN

CUSTOM FEATURES SHOWN

MD4M-57-63



FINISHES:
POWDERCOAT,
TEXTURED BLACK



FINISHES:
LAMINATE,
VAPOR STRANDZ (4939K)

MD4M-76-63



FINISHES:
POWDERCOAT,
TEXTURED BLACK



FINISHES:
LAMINATE,
SPROUT (4918)

MD4M-96-63



FINISHES:
POWDERCOAT,
TEXTURED BLACK



FINISHES:
LAMINATE,
OLD MILL OAK (7973K)

FIVE-LEVEL UPRIGHT SELF-SERVICE DISPLAY - 76"H

 REFRIGERATED



Standard features shown



Custom options available, refer to options schedule on next page.

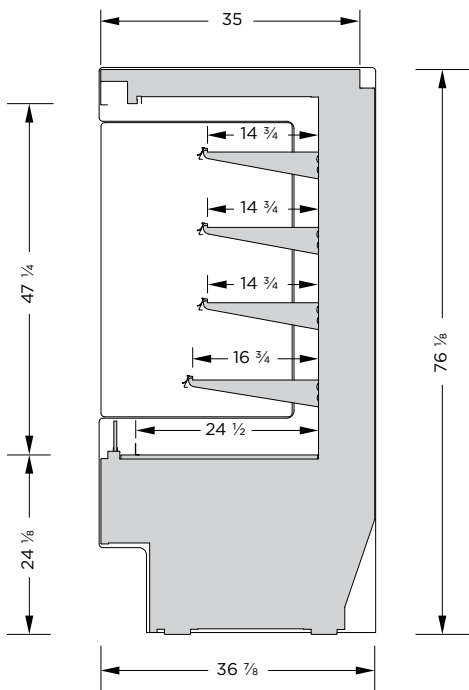

MODEL	LENGTH
MD5M-38-76	40 1/4"
MD5M-48-76	49 7/8"
MD5M-57-76	59 3/8"
MD5M-76-76	78 1/2"
MD5M-96-76	97 5/8"

FEATURES:

- Many exterior finish options available: powdercoat paint, brushed stainless steel, laminates and natural wood finishes
- 3 interior finish options: textured powdercoat black, white and brushed stainless steel
- Other custom options are offered. Refer to the options schedule on the next page
- A LED light strip is mounted on the top ledge of the display area.
- 3-14" and 1-16" adjustable metal shelves with integrated LED lighting.
- The LED lighting is available in various light intensities/spectrums
- Designed to maintain the critical temperature of the products within the display at a range of 38- 41°F (3-5°C) with an ambient atmosphere of 75°F (24°C)/55% humidity
- ETL electrical certification and NSF 7 standards
- New R-513A (non-ozone depleting, low global warming potential) refrigerant used in the self-contained refrigeration system
- The refrigeration system is designed to pull fresh air through a rear vent and exhaust air through a front grill integrated in the base of the display
- Remote refrigeration available. Contact Cayuga Displays for details

SUGGESTED APPLICATIONS:

 Cafe

 Deli

 Bakery

 Restaurant

Note: Information and specifications may change due to engineering improvements.



FIVE-LEVEL UPRIGHT SELF-SERVICE DISPLAY - 76" H

REFRIGERATED

TECHNICAL SPECS				
MODEL	LENGTH	VOLTS	AMPS	NEMA PLUG
MD5M-38-76	40 ¼"	115/230	9.2	L14-20P
MD5M-48-76	49 ⅞"	115/230	9.2	L14-20P
MD5M-57-76	59 ⅜"	115/230	9.7	L14-20P
MD5M-76-76	78 ½"	115/230	TBD	TBD
MD5M-96-76	97 ⅝"	115/230	TBD	TBD

STANDARD FEATURES:

- 3 interior finish options: textured powdercoat black, white and brushed stainless steel
- Black or white laminate exterior finish
- Solid End Panels with black or white interior finish
- A LED light strip is mounted on the top ledge of the display area
- 3-14" and 1-16" adjustable metal shelves with integrated LED lighting
- The refrigeration system is designed to pull fresh air through a rear and exhaust air through a front grill integrated in the base of the display

CUSTOM FEATURES:

EXTERIOR FINISHES	
Formica laminate finish: _____	
Other laminate finish (specify): _____	
Customer laminate choices	
Brushed Stainless Steel	
Oak Veneer Plywood	
- Vertical grain direction	
- Horizontal grain direction	
Birch/Maple Veneer Plywood	
- Vertical grain direction	
- Horizontal grain direction	
Clear finish applied to veneer	
Stain finish Choice: _____	
1" black McCue impact bumper strip applied to the front of the display	
Other McCue impact bumper strip colors available upon request	

END PANELS

Interior laminate the same as exterior	
Brushed Stainless Steel interior	
Mirrored interior	
Tempered glass end panels	
Mirrored glass panels	
1" black McCue impact bumper strip applied to the front of the display	
Other McCue impact bumper strip colors available upon request	

MISCELLANEOUS

Additional shelf with integrated LED lighting	
Roll-down thermal night curtain	

ADDITIONAL FEATURES:

- Designed to maintain the critical temperature of the products within the display at a range of 38-41°F (3-5°C) with an ambient atmosphere of 75° (24°C)/55% humidity. Designed for holding pre-chilled product only
- Hot gas condensate evaporation system (most units)
- ETL listed and sanitation certified to NSF 7
- 1 year parts and labor warranty

FIVE-LEVEL UPRIGHT SELF-SERVICE DISPLAY - 76”H

STANDARD FEATURES SHOWN

CUSTOM FEATURES SHOWN

MD5M-38-76



FINISHES:
POWDERCOAT,
TEXTURED BLACK



FINISHES:
LAMINATE,
PLANKED URBAN OAK (9312)

MD5M-48-76



FINISHES:
POWDERCOAT,
TEXTURED BLACK



FINISHES:
LAMINATE,
SEASONED PLANKED ELM (6477)

MD5M-57-76



FINISHES:
POWDERCOAT,
TEXTURED BLACK



FINISHES:
LAMINATE,
WALNUT FIBERWOOD (8915)

FIVE-LEVEL UPRIGHT SELF-SERVICE DISPLAY - 76”H

STANDARD FEATURES SHOWN

CUSTOM FEATURES SHOWN

MD5M-76-76



FINISHES:
POWDERCOAT,
TEXTURED BLACK



FINISHES:
LAMINATE,
NOIR CEDAR (1547)

MD5M-96-76



FINISHES:
POWDERCOAT,
TEXTURED BLACK



FINISHES:
LAMINATE,
PLANKED URBAN OAK (9312)

REFRIGERATED DISPLAY ACCESSORIES

2 1/2" X 13" SINGLE STEP RISER

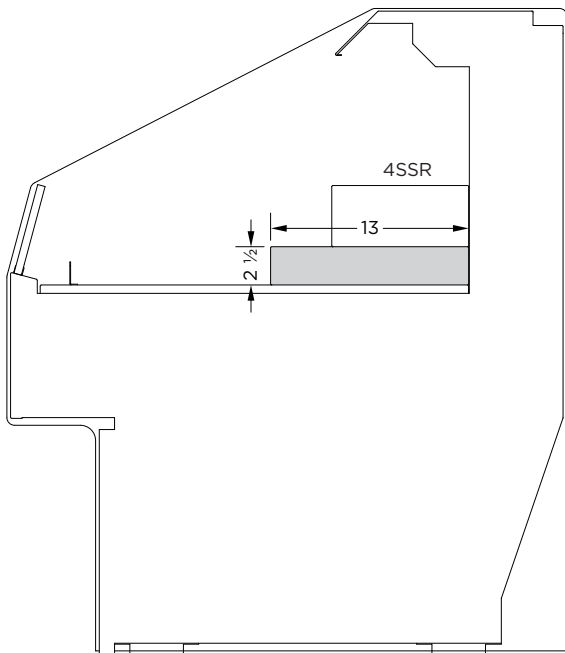

DISPLAY WIDTH	PART #	QTY
24"	2SSR-24-P*, S*	1
38"	2SSR-38-P, S	1
48"	2SSR-48-P, S	1
57"	2SSR-57-P, S	1
76"	2SSR-38-P, S	2
96"	2SSR-48-P, S	2

P = Painted powdercoat finish
S = Brushed stainless steel

4" X 9" SINGLE STEP RISER

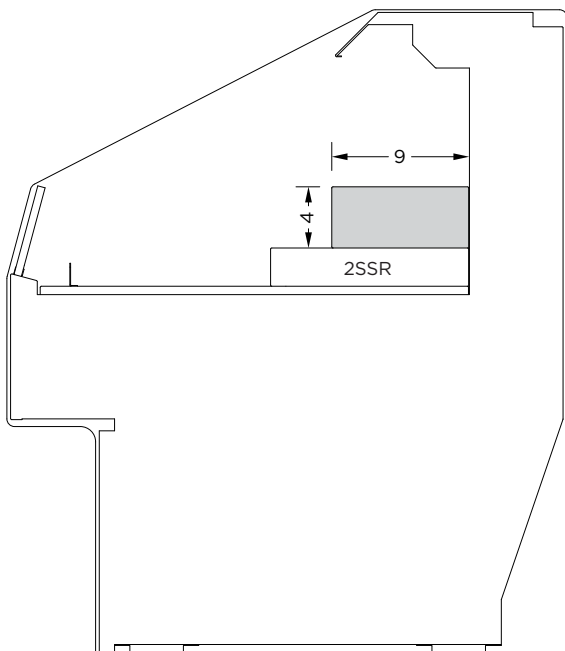

DISPLAY WIDTH	PART #	QTY
24"	4SSR-24-P*, S*	1
38"	4SSR-38-P, S	1
48"	4SSR-48-P, S	1
57"	4SSR-57-P, S	1
76"	4SSR-38-P, S	2
96"	4SSR-48-P, S	2

P = Painted powdercoat finish
S = Brushed stainless steel

REFRIGERATED DISPLAY ACCESSORIES

THREE TIER STEPPED RISER

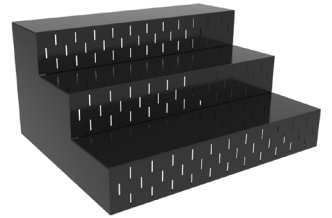
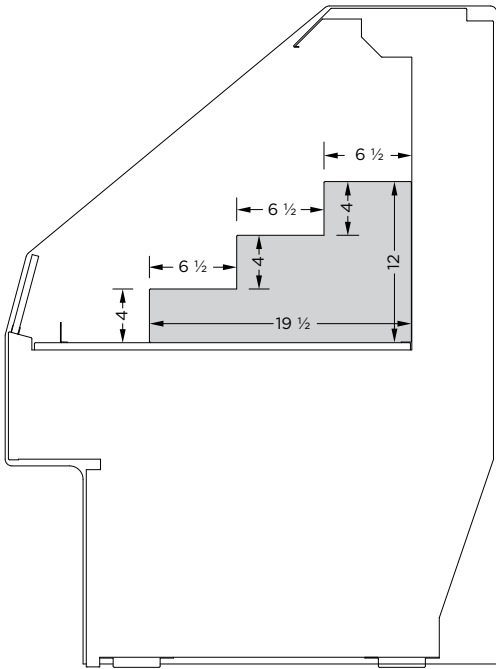

DISPLAY WIDTH	PART #	QTY
24"	3TSR-24-P*, S*	1
38"	3TSR-19-P, S	2
48"	3TSR-24-P, S	2
57"	3TSR-19-P, S	3
76"	3TSR-19-P, S	4
96"	3TSR-24-P, S	4

P = Painted powdercoat finish
S = Brushed stainless steel

FOUR TIER STEPPED RISER

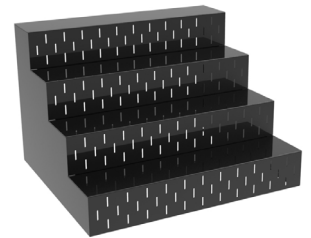
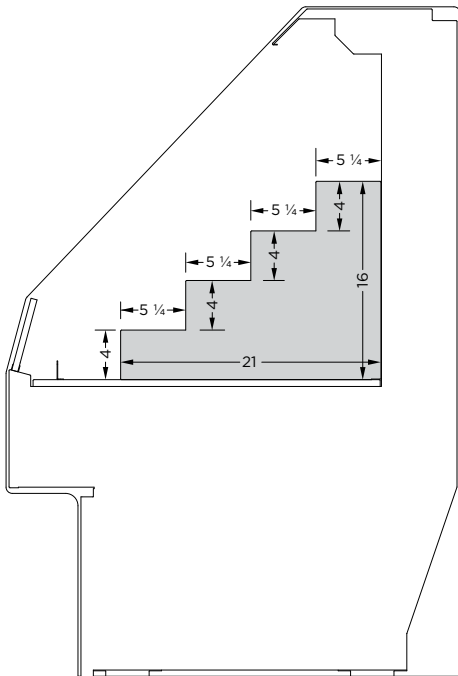

DISPLAY WIDTH	PART #	QTY
24"	4TSR-24-P*, S*	1
38"	4TSR-19-P, S	2
48"	4TSR-24-P, S	2
57"	4TSR-19-P, S	3
76"	4TSR-19-P, S	4
96"	4TSR-24-P, S	4

P = Painted powdercoat finish
S = Brushed stainless steel

REFRIGERATED DISPLAY ACCESSORIES

CLIP-IN ANGLED BASE INLAY

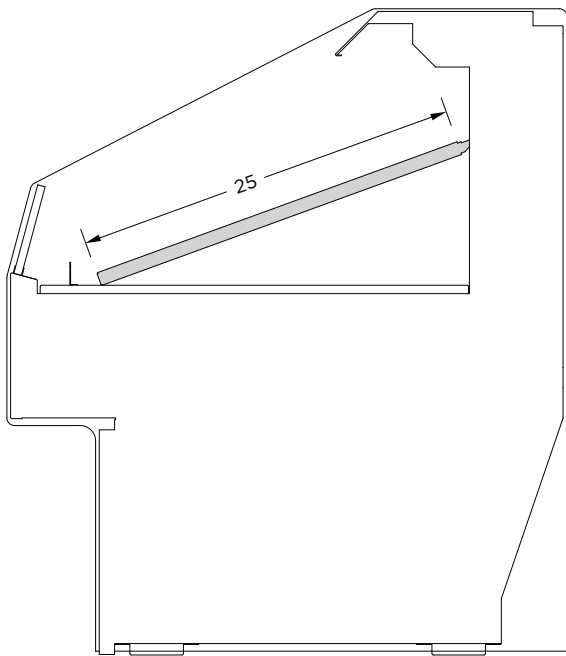

DISPLAY WIDTH	PART #	QTY
24"	ABI-24-P*, S*	1
38"	ABI-38-P, S	1
48"	ABI-48-P, S	1
57"	ABI-57-P, S	1
76"	ABI-38-P, S	2
96"	ABI-48-P, S	2

P = Painted powdercoat finish
S = Brushed stainless steel

TOP MOUNTED CLIP-ON DRY SHELF

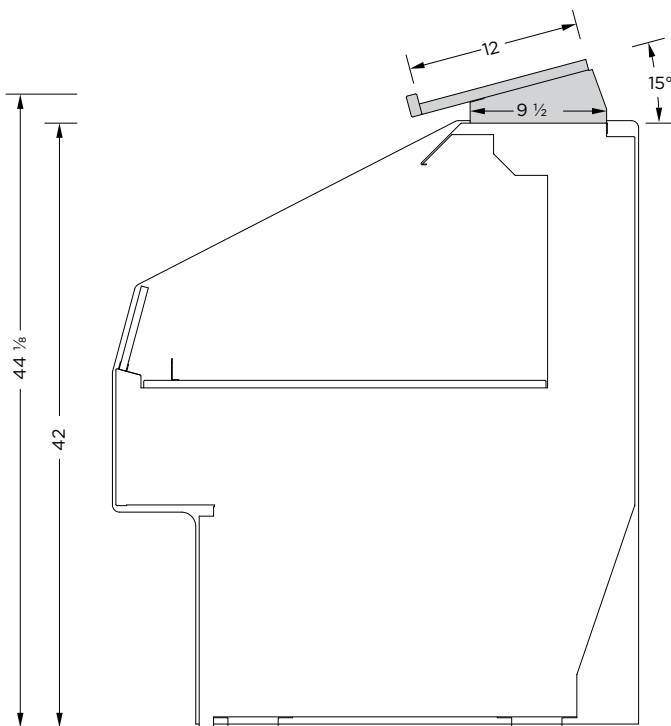

DISPLAY WIDTH	PART #
24"	CDS-24
38"	CDS-38
48"	CDS-48

REFRIGERATED DISPLAY ACCESSORIES

CLIP-ON SIGN PANEL

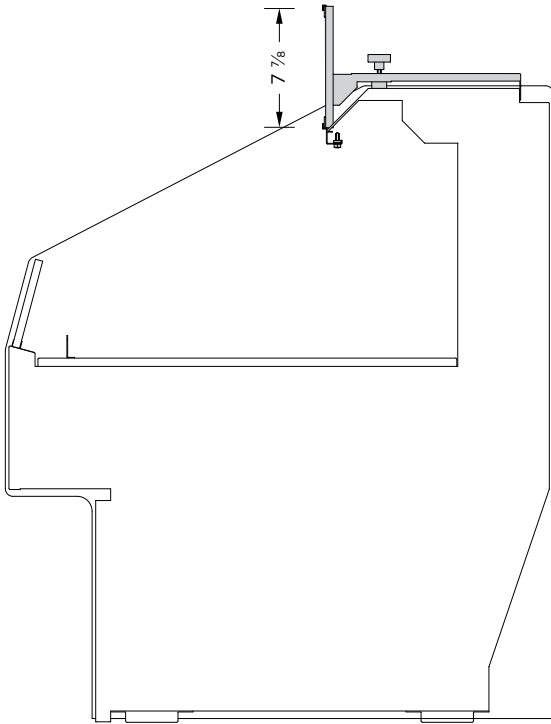

DISPLAY WIDTH	PART #
24"	CSP-24-P*, S*
38"	CSP-38-P, S
48"	CSP-48-P, S

P = Painted powdercoat finish
S = Brushed stainless steel

FEATURES:

- Plastic channels top & bottom to hold paper signs
- 3-track sign available

RAISED TOP MOUNTED CLIP-ON DRY SHELF

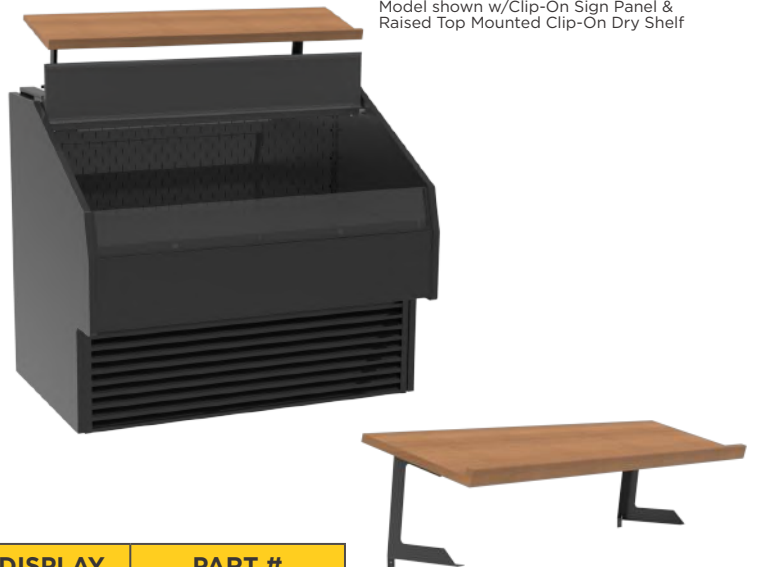
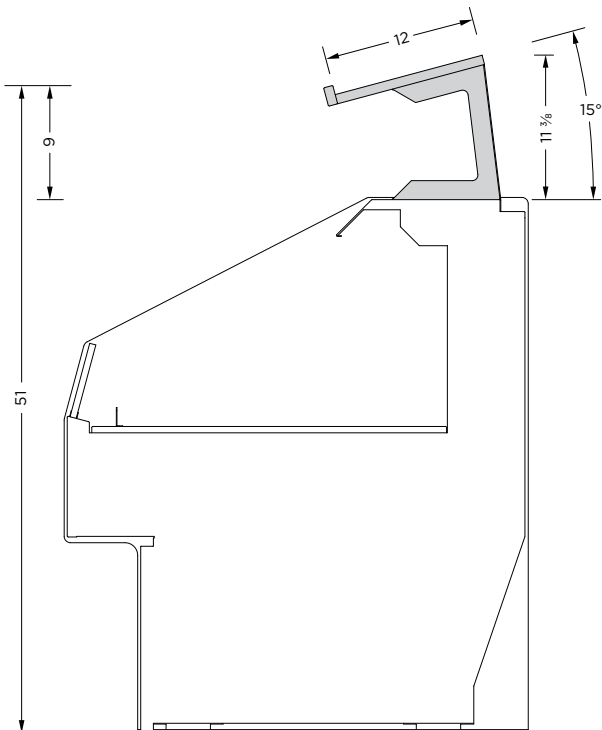

Model shown w/Clip-On Sign Panel & Raised Top Mounted Clip-On Dry Shelf

DISPLAY WIDTH	PART #
24"	RCDS-24
38"	RCDS-38
48"	RCDS-48

CURVED GLASS SERVICE DISPLAY

 REFRIGERATED

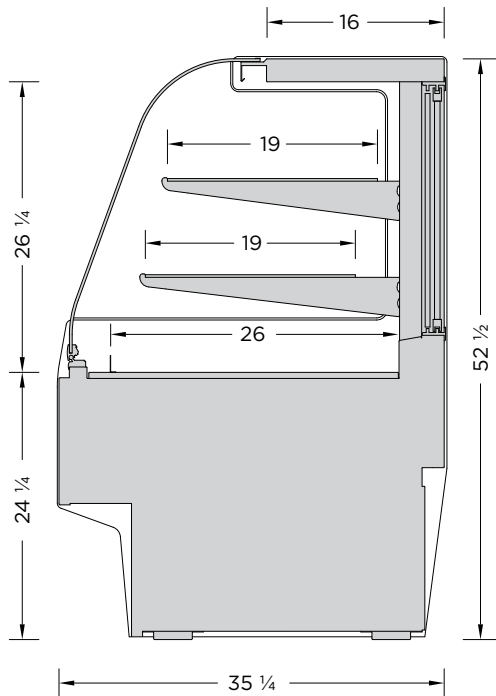



MODEL	LENGTH
DC-RS3M-38	40 1/4"
DC-RS3M-48	49 7/8"
DC-RS3M-57	59 3/8"
DC-RS3M-76	78 1/2"
DC-RS3M-96	97 5/8"

FEATURES:

- 3 interior finishes, textured black, white or brushed stainless steel
- Many exterior colors, patterns and wood grain finishes available
- R-513A self-contained refrigeration
- 2-19" adjustable tempered glass shelves with integrated LED lighting
- Removable base deck panels for easy cleaning and service
- Tilt-out front glass for easy cleaning
- Air circulating defogging system to keep the front glass clear of condensation
- LED lighting attached to the top ledge of the display
- Thermal rear sliding doors
- The refrigeration system is designed to pull fresh air and heated exhaust air through a front vent integrated in the base of the display
- Many custom options available. Refer to the options schedule on next page

SUGGESTED APPLICATIONS:

-  Wine & Liquor
-  Restaurant
-  Cafe
-  Butcher Shop
-  Bakery
-  Deli

Note: Information and specifications may change due to engineering improvements.



CURVED GLASS SERVICE DISPLAY

 REFRIGERATED

TECHNICAL SPECS			
MODEL	VOLTS	AMPS	NEMA PLUG
DC-RS3M-38	115	8.2	5-15P
DC-RS3M-48	115	12.0	5-20P
DC-RS3M-57	115	12.1	5-20P
DC-RS3M-76	115/230	9.9	L14-20P
DC-RS3M-96	115/230	9.9	L14-20P

STANDARD FEATURES:

- Textured black or white interior finish
- Black or white laminate exterior finish
- 2-19" adjustable tempered glass shelves with integrated LED lighting
- LED lighting attached at the top of the service display
- Thermal glass rear sliding doors
- Tilt-out curved front glass
- Air circulating defogging system to keep front glass clear of condensation

CUSTOM FEATURES:

EXTERIOR FINISHES	
Formica laminate finish: _____	
Other laminate finish (specify): _____	
Customer laminate choices	
Oak Veneer Plywood	
- Vertical grain direction	
- Horizontal grain direction	
Birch/Maple Veneer Plywood	
- Vertical grain direction	
- Horizontal grain direction	
Clear Finish applied to veneer	
Stain finish Choice: _____	
1" black McCue impact bumper strip applied to the front of the display	
Other McCue impact bumper strip colors Available upon request	

END PANELS	
Solid	
- LH (visualized from the front)	
- RH (visualized from the front)	
Interior laminate the same as exterior	
Mirrored interior	
Brushed Stainless Steel interior	
Mirrored end panel glass	
Stainless Steel T-mold edging	
1" black McCue impact bumper strip applied to the outside of the end panel	
Other McCue impact bumper strip colors available upon request	

MISCELLANEOUS	
Heavy duty lockable casters	
Rear fold-down work shelf	
Add one shelf level (with LED light strip)	
Eliminate 1 shelf level	
Mirror rear sliding doors	
Locks for rear sliding doors	
Price tag mold strip for tempered glass shelves	

ADDITIONAL FEATURES:

- Designed to maintain product temperature of 38-41°F with a maximum ambient atmosphere of 75°F/55% humidity
- Hot gas condensate evaporation system
- ETL Listed and Sanitation certified to NSF 7
- 1 Year Parts & Labour Warranty
- Rear air intake, front discharge. Avoid any obstructions in these areas

CURVED GLASS DRY SERVICE DISPLAY

□ AMBIENT

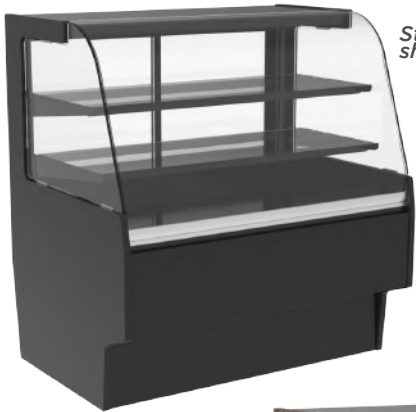

Standard features shown



Custom options available, refer to options schedule on next page

MODEL	LENGTH
DC-DS3M-38	40 1/4"
DC-DS3M-48	49 7/8"
DC-DS3M-57	59 3/8"
DC-DS3M-76	78 1/2"
DC-DS3M-96	97 5/8"

FEATURES:

- 3 interior finishes, textured black, white or brushed stainless steel
- Many exterior colors, patterns and wood grain finishes available
- 2-19" adjustable tempered glass shelves with integrated LED lighting
- Tilt-out curved front glass for easy cleaning
- LED lighting attached to the top ledge of the display
- Rear sliding doors
- Many custom options available. Refer to the options schedule on next page

SUGGESTED APPLICATIONS:



Note: Information and specifications may change due to engineering improvements.

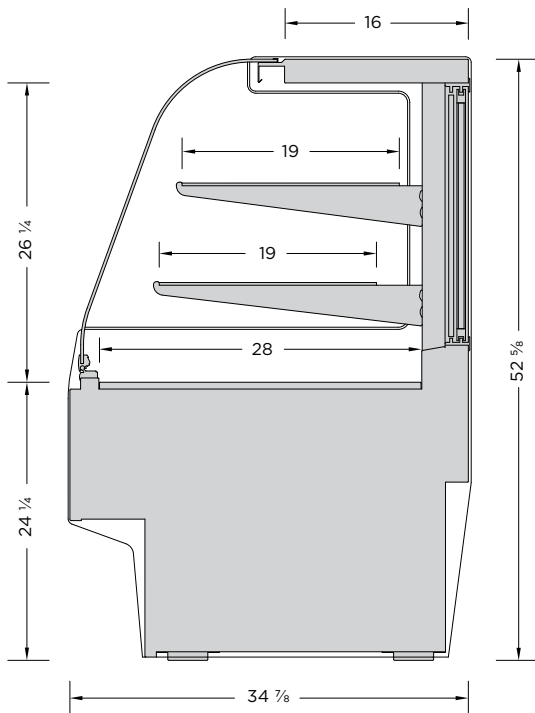



CURVED GLASS DRY SERVICE DISPLAY

□ AMBIENT

TECHNICAL SPECS			
MODEL	VOLTS	AMPS	NEMA PLUG
DC-DS3M-38	115	0.5	5-15P
DC-DS3M-48	115	0.5	5-15P
DC-DS3M-57	115	1.0	5-15P
DC-DS3M-76	115	1.0	5-15P
DC-DS3M-96	115	1.0	5-15P

STANDARD FEATURES:

- Textured black or white interior finish
- Black or white laminate exterior finish
- 2-19" adjustable tempered glass shelves with integrated LED lighting
- LED lighting attached at the top of the service display
- Glass rear sliding doors
- Tilt-out curved front glass

CUSTOM FEATURES:

EXTERIOR FINISHES	
Formica laminate finish: _____	
Other laminate finish (specify): _____	
Customer laminate choices	
Oak Veneer Plywood	
- Vertical grain direction	
- Horizontal grain direction	
Birch/Maple Veneer Plywood	
- Vertical grain direction	
- Horizontal grain direction	
Clear Finish applied to veneer	
Stain finish Choice: _____	
1" black McCue impact bumper strip applied to the front of the display	
Other McCue impact bumper strip colors Available upon request	

END PANELS	
Solid	
- LH (visualized from the front)	
- RH (visualized from the front)	
Interior laminate the same as exterior	
Mirrored interior	
Brushed Stainless Steel interior	
Mirrored end panel glass	
Stainless Steel T-mold edging	
1" black McCue impact bumper strip applied to the outside of the end panel	
Other McCue impact bumper strip colors available upon request	

MISCELLANEOUS	
Heavy duty lockable casters	
Rear fold-down work shelf	
Add 1 shelf level (with LED light strip)	
Eliminate 1 shelf level	
Mirrored rear sliding doors	
Locks for rear sliding doors	
Price tag mold strip for tempered glass shelves	

ADDITIONAL FEATURES:

- ETL Listed and Sanitation certified to NSF 7
- 1 Year Parts & Labour Warranty

SQUARE GLASS SERVICE DISPLAY

 REFRIGERATED



Standard features shown



Custom options available, refer to options schedule on next page

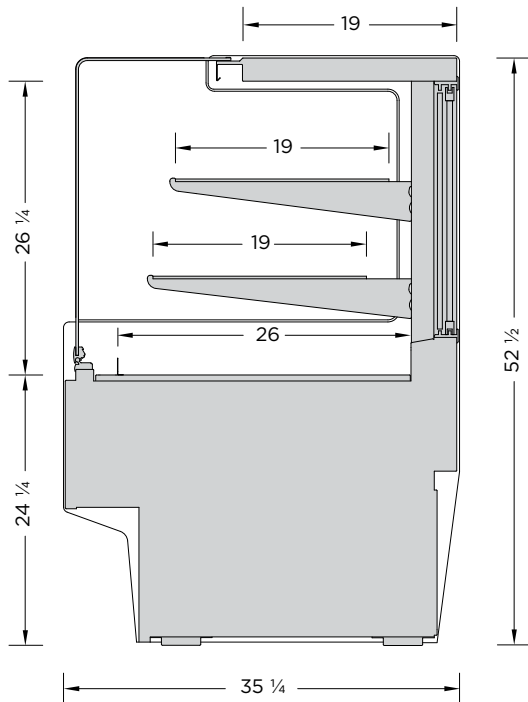







MODEL	LENGTH
SG-RS3M-38	40 1/4"
SG-RS3M-48	49 7/8"
SG-RS3M-57	59 3/8"
SG-RS3M-76	78 1/2"
SG-RS3M-96	97 5/8"

FEATURES:

- 3 interior finishes, textured black, white or brushed stainless steel
- Many exterior colors, patterns and wood grain finishes available
- R-513A self-contained refrigeration
- Two 19" adjustable tempered glass shelves with integrated LED lighting
- Removable base deck panels for easy cleaning and service
- Air circulating defogging system to keep the front glass clear of condensation
- LED lighting attached to the top ledge of the display
- Thermal rear sliding doors
- Exclusive one piece 90° bent front glass for better visibility and glass alignment
- Tilt-out front glass for easy cleaning
- The refrigeration system is designed to pull fresh air and heated exhaust air through a front vent integrated in the base of the display
- Many custom options available. Refer to the options schedule on next page

SUGGESTED APPLICATIONS:

-  Wine & Liquor
-  Restaurant
-  Cafe
-  Butcher Shop
-  Bakery
-  Deli

Note: Information and specifications may change due to engineering improvements.



SQUARE GLASS SERVICE DISPLAY

 REFRIGERATED

TECHNICAL SPECS			
MODEL	VOLTS	AMPS	NEMA PLUG
SG-RSH3M-38	115	8.2	5-15P
SG-RSH3M-48	115	12.0	5-20P
SG-RSH3M-57	115	12.1	5-20P
SG-RSH3M-76	115/230	9.9	L14-20P
SG-RSH3M-96	115/230	9.9	L14-20P

STANDARD FEATURES:

- Textured black or white interior finish
- Black or white laminate exterior finish
- Two 19" adjustable tempered glass shelves with integrated LED lighting
- LED lighting attached at the top of the service display
- Thermal glass rear sliding doors
- Tilt-out one-piece 90° square front glass
- Air circulating defogging system to keep the front glass clear of condensation

CUSTOM FEATURES:

EXTERIOR FINISHES	
Formica laminate finish: _____	
Other laminate finish (specify): _____	
Customer laminate choices	
Oak Veneer Plywood	
- Vertical grain direction	
- Horizontal grain direction	
Birch/Maple Veneer Plywood	
- Vertical grain direction	
- Horizontal grain direction	
Clear Finish applied to veneer	
Stain finish Choice: _____	
1" black McCue impact bumper strip applied to the front of the display	
Other McCue impact bumper strip colors Available upon request	

END PANELS	
Solid	
- LH (visualized from the front)	
- RH (visualized from the front)	
Interior laminate the same as exterior	
Mirrored interior	
Brushed Stainless Steel interior	
Mirrored end panel glass	
Stainless Steel T-mold edging	
1" black McCue impact bumper strip applied to the outside of the end panel	
Other McCue impact bumper strip colors available upon request	

MISCELLANEOUS	
Heavy duty lockable casters	
Rear fold-down work shelf	
Add 1 shelf level (with LED light strip)	
Eliminate 1 shelf level	
Mirrored rear sliding doors	
Locks for rear sliding doors	
Price tag mold strip for tempered glass shelves	

ADDITIONAL FEATURES:

- Designed to maintain product temperature of 38-41°F with a maximum ambient atmosphere of 75°F/55% humidity
- Hot gas condensate evaporation system
- ETL Listed and Sanitation certified to NSF 7
- 1 Year Parts & Labour Warranty
- Rear air intake, front discharge. Avoid any obstructions in these areas

SQUARE GLASS DRY SERVICE DISPLAY

□ AMBIENT



MODEL	LENGTH
SG-DS3M-38	40 ¼"
SG-DS3M-48	49 ⅞"
SG-DS3M-57	59 ⅜"
SG-DS3M-76	78 ½"
SG-DS3M-96	97 ⅝"

FEATURES:

- 3 interior finishes, textured black, white or brushed stainless steel
- Many exterior colors, patterns and wood grain finishes available
- Two 19" adjustable tempered glass shelves with integrated LED lighting
- Tilt-out front glass for easy cleaning
- LED lighting attached to the top ledge of the display
- Rear sliding doors
- Exclusive one piece 90° bent front glass for better presentation and alignment
- Many custom options available. Refer to the options schedule on next page

SUGGESTED APPLICATIONS:



Note: Information and specifications may change due to engineering improvements.

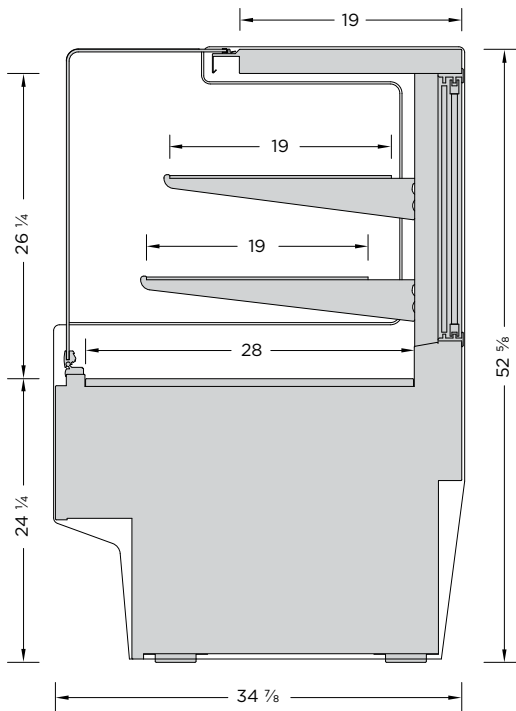



SQUARE GLASS DRY SERVICE DISPLAY

□ AMBIENT

TECHNICAL SPECS			
MODEL	VOLTS	AMPS	NEMA PLUG
SG-DH3-38	115	0.5	5-15P
SG-DH3-48	115	0.5	5-15P
SG-DH3-57	115	1.0	5-15P
SG-DH3-76	115	1.0	5-15P
SG-DH3-96	115	1.0	5-15P

STANDARD FEATURES:

- Textured black or white interior finish
- Black or white laminate exterior finish
- Two 19" adjustable tempered glass shelves with integrated LED lighting
- LED lighting attached at the top of the service display
- Glass rear sliding doors
- Tilt-out one-piece 90° square front glass

CUSTOM FEATURES:

EXTERIOR FINISHES	
Formica laminate finish: _____	
Other laminate finish (specify): _____	
Customer laminate choices	
Oak Veneer Plywood	
- Vertical grain direction	
- Horizontal grain direction	
Birch/Maple Veneer Plywood	
- Vertical grain direction	
- Horizontal grain direction	
Clear Finish applied to veneer	
Stain finish Choice: _____	
1" black McCue impact bumper strip applied to the front of the display	
Other McCue impact bumper strip colors Available upon request	

END PANELS	
Solid	
- LH (visualized from the front)	
- RH (visualized from the front)	
Interior laminate the same as exterior	
Mirrored interior	
Brushed Stainless Steel interior	
Mirrored end panel glass	
Stainless Steel T-mold edging	
1" black McCue impact bumper strip applied to the outside of the end panel	
Other McCue impact bumper strip colors available upon request	

MISCELLANEOUS	
Heavy duty lockable casters	
Rear fold-down work shelf	
Add 1 shelf level (with integrated LED light strip)	
Eliminate 1 shelf level	
Mirrored rear sliding doors	
Locks for rear sliding doors	
Price tag mold strip for tempered glass shelves	

ADDITIONAL FEATURES:

- ETL Listed and Sanitation certified to NSF 7
- 1 Year Parts & Labour Warranty

SELF-CONTAINED FRONT SELF-SERVICE DISPLAY, REAR PREPARATION STATION & REFRIGERATED BASE STORAGE CABINET

 REFRIGERATED



Standard features shown
Pots not included

* FOOD PANS NOT INCLUDED



Custom options available, refer to options schedule on next page.

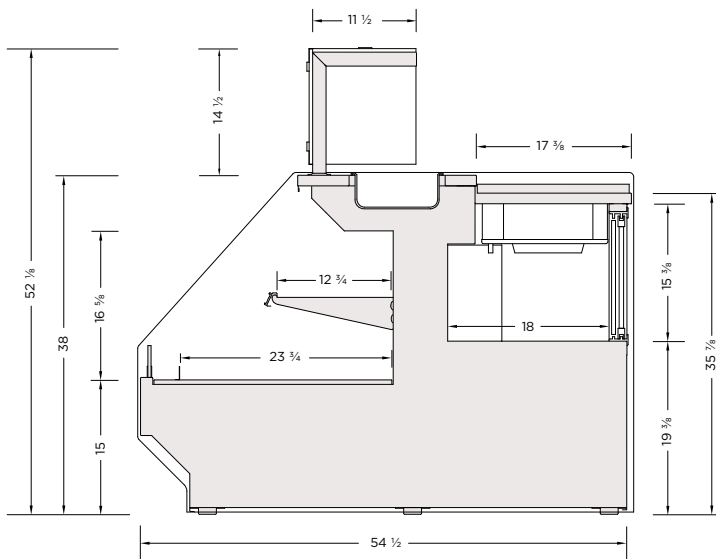

MODEL	LENGTH
Ouw-4838-MS	50 1/4"
Ouw-6038-MS	62 3/8"
Ouw-7238-MS	74 1/2"
Ouw-9638-MS	98 1/2"

FEATURES:

- Brushed stainless steel internal cabinet construction.
- Many exterior finish options available: powder coat paint, brushed stainless steel, decorative laminates and natural wood finishes.
- Three interior finish options: textured powder coat black, white and brushed stainless steel.
- The front décor panel can be extended to provide a more finished cabinet look. (A)
- Other custom options are offered. Refer to the options schedule on the next page.
- The refrigerated front self-service display has a LED light strip mounted to the top ledge of the display area, and one 12"D adjustable metal shelf with a front product stop and LED light strip mounted to the bottom of the shelf.
- The refrigerated rear storage cabinet is constructed of brushed stainless steel and has rear thermal sliding doors.
- The top preparation area has an integrated front refrigerated well to hold a series of food pans. The prep counter is brushed stainless steel and has a removeable white nylon cutting board.
- The top preparation area is protected with a front mounted tempered glass sneeze guard, top shelf and end panels.
- Designed to maintain the critical temperature of the products within the display, the storage cabinet and the top refrigerated well at a range of 38-41°F (3-5°C) with an ambient atmosphere of 75°F (24°C)/55% humidity.
- New R-513A (non-ozone depleting, low global warming potential) refrigerant used in the self-contained refrigeration system.
- ETL electrical certification and NSF-7 standards.
- The refrigeration system is located below the rear storage cabinet, pulling fresh air from the far right side of the display and exhausting heat on the far left.
- The refrigeration system is adjusted by two temperature controllers, one to control the front and top display and the other to control the rear storage cabinet.
- Condensate water is removed by an electrical evaporator. The top refrigerated well has a separate drain with a shutoff for cleaning purposes.
- Remote refrigeration available. Contact Cayuga Displays for details.

Note: Information and specifications may change due to engineering improvements.



SELF-CONTAINED FRONT SELF-SERVICE DISPLAY, REAR PREPARATION STATION & REFRIGERATED BASE STORAGE

 REFRIGERATED

TECHNICAL SPECS				
MODEL	LENGTH	VOLTS	AMPS	NEMA PLUG
OUW-4838-MS	50 ¼"	115/230	9.5	L14-20P
OUW-6038-MS	62 ¾"	115/230	9.5	L14-20P
OUW-7238-MS	74 ½"	115/230	16.0	L14-20P
OUW-9638-MS	98 ½"	115/230	16.0	L14-20P

STANDARD FEATURES:

- Black or white textured powder coat interior
- Black or white exterior
- Solid end panels
- LED light strip mounted to the top ledge of the self-service display
- 1-12" adjustable metal shelf with a front product stop and LED light strip mounted to the bottom of the shelf
- Brushed stainless steel refrigerated base storage cabinet with thermal sliding doors
- Top front mounted refrigerated well for food pans
- Brushed stainless steel preparation countertop with a white nylon cutting board
- The preparation area is protected by a 14"H front mounted tempered glass sneeze guard, 12"D top shelf and end panels
- A front mounted refrigerated well holds a series of food pans
- The refrigerated well has a separate drain line with a shut-off used for cleaning purposes
- The refrigeration system is located below the rear storage cabinet, pulling fresh air from the far right side of the display and exhaust air on the far left.
- The system has two temperature controllers, one to control the front and top display, the other for the rear storage cabinet.
- Condensate water is removed by an electrical evaporator

CUSTOM FEATURES:

END PANELS	
Interior laminate the same as exterior	
Brushed Stainless Steel interior	
Mirrored interior	
Tempered glass end panels	
Mirrored glass panels	
1" black McCue impact bumper strip applied to the outside of the end panel	
Other McCue impact bumper strip colors available upon request	

COUNTERTOP	
Front Ledge Countertop	
- Granite	
- Quartz	
- Solid Surfacing	

FRONT TEMPERED GLASS SNEEZEGUARD	
Seamless base mounted sneezeguard	

INTERIOR FINISH	
Brushed stainless steel	

FRONT DÉCOR PANEL	
Extended to 9"	

EXTERIOR FINISHES	
Formica laminate finish: _____	
Other laminate finish (specify): _____	
Other custom laminate specs:	
Brushed Stainless Steel	
Oak Veneer Plywood	
- Vertical grain direction	
- Horizontal grain direction	
Birch/Maple Veneer Plywood	
- Vertical grain direction	
- Horizontal grain direction	
Clear finish applied to veneer	
Stain finish Choice: _____	
1" black McCue impact bumper strip applied to the front of the display	
Other McCue impact bumper strip colors available upon request	

MISCELLANEOUS	
Pull down night curtain for front display	
PTM on shelf front	
2 ½" Inlay Riser Step	
4" Inlay Riser Step	
Additional shelf level with integrated LED light strip	
Perforated angled inlay panel	

ADDITIONAL FEATURES:

- Designed to maintain the critical temperature of the products within the display at a range of 38-41°F (3- 5°C) with an ambient atmosphere of 75°F (24°C)/55% humidity. Designed for holding pre chilled product only
- Electrical condensate evaporation system
- ETL listed and sanitation certified to NSF 7
- 1 year parts and labor warranty

SELF-CONTAINED FRONT SELF-SERVICE DISPLAY, REAR PREP STATION & REFRIGERATED BASE STORAGE

STANDARD FEATURES SHOWN

CUSTOM FEATURES SHOWN

Ouw-4838-MS



FINISHES:
POWDERCOAT,
TEXTURED BLACK



FINISHES:
LAMINATE,
WINDSWEPT BRONZE (4795)

Ouw-6038-MS



FINISHES:
POWDERCOAT,
TEXTURED BLACK



FINISHES:
LAMINATE,
BARZILWOOD (7946)

Ouw-7238-MS



FINISHES:
POWDERCOAT,
TEXTURED BLACK

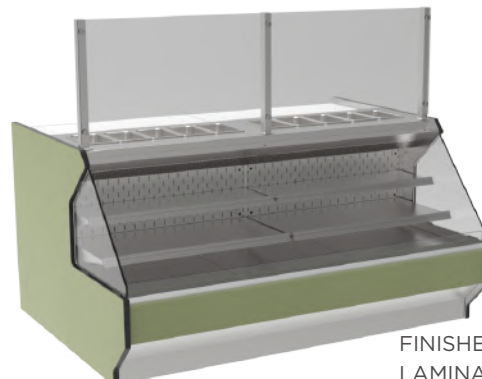

FINISHES:
LAMINATE,
SPROUT (74918)

SELF-CONTAINED FRONT SELF-SERVICE DISPLAY, REAR PREP STATION & REFRIGERATED BASE STORAGE

STANDARD FEATURES SHOWN

CUSTOM FEATURES SHOWN

O UW-9638-MS



FINISHES:
POWDERCOAT,
TEXTURED BLACK



FINISHES:
LAMINATE,
OLD MILL OAK (7973K)



Formica® Laminate

Formica Group provides surfaces that fuse beautiful design with purposeful functionality. Formica® Products provide versatile surfacing solutions that are inspired by and adapt to the way people live, work and play.

Formica® Brand Laminate offers a broader range of looks than ever before. Transform spaces with our modern laminates that are as beautiful as they are durable. Mix and match solids, patterns and finishes.

Product Features:

- Postforming
- Durable and Wear-resistant
- Horizontal and Vertical
- Impact Resistant

Formica® EliteForm

Our innovative Formica® EliteForm surfacing technology redefines the performance attributes of high pressure laminate to deliver a more durable laminate for today’s market. Formica® Laminate with EliteForm features superior scratch resistance over other laminate brands, the ability to postform to a smaller radius with better blister resistance, and more durable, long-lasting surfaces, including the Gloss texture in horizontal applications. EliteForm comes standard on all Formica® Laminates, at no additional cost.

Price Group One: All Colours are matte (-58) finish

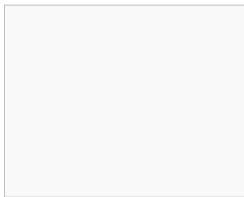

949
White

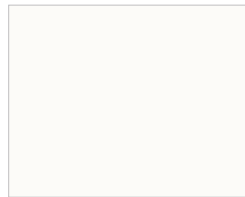

7197
Dover White

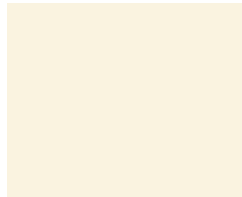

920
Almond

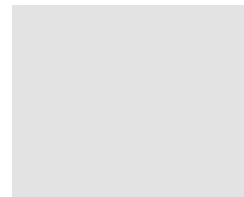

927
Folkstone



961
Fog



845
Spectrum Red



7897
Spectrum Green



914
Marine Blue



2297
Terril

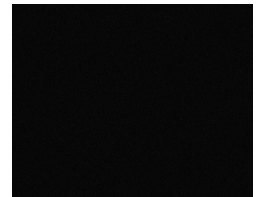

909
Black



6696
Carrara Bianco

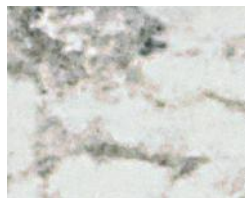

9476
White Ice Granite



9497
Silver Quartzite



7732
Butterum Granite

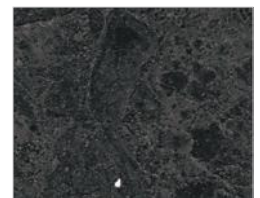

9527
Black Shalestone



8844
Aged Ash

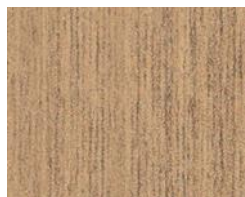

5883
Pecan Woodline

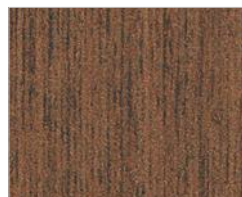

5884
Chestnut Woodline



9283
Walnut Riftwood

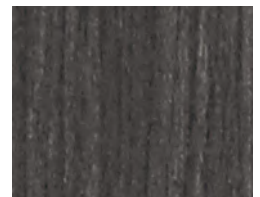

6414
Black Riftwood

Price Group Two: All Colours are matte finish



6997
Pale Brushstroke



6998
Wood Brushstroke

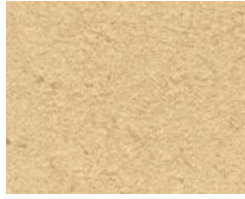

7813
Cardboard Solidz



9319
Stainless



8918
Blackened Steel



9310
White Marble Herringbone

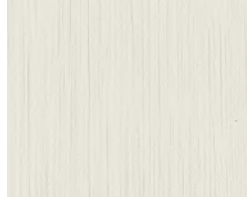

9285
White Twill

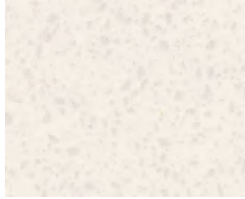

6698
Paloma Pear



503
Stone Grafix



8830
Elemental Concrete



8841
White Ash



5785
Ashwood Beige



5795
Camel Elm



8845
Bleached Legno



8916
Blackened Fiberwood

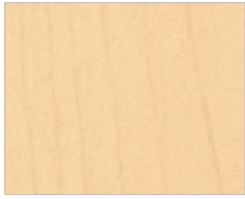

86992
Hardrock Maple



7012
Amber Maple



8677
Scandi Rift Oak



6995
Cherry Walnut



7759
Select Cherry



Formica Canada Inc. is located in St-jean-sur-Richelieu, Quebec, and employs more than 250 people.

Formica Canada is proud to be part of the Well Made Here local purchasing program.

As the inventor of high pressure laminate, Formica Corporation has always worked to provide innovative, high quality products. Efficient use of resources is at our core, and we have taken many steps to improve our environmental footprint - from reusing the water in our presses to incorporating recycled materials into our surfacing products. We are committed to a long-term planning horizon that includes becoming an industry-leading environmental steward.



For larger laminate sample, please visit:
cayugadisplays.com 1-800-839-5536
formica.com 1-800-FORMICA™

PAINTED METAL

- **Standard products in stock**
- **RAL Program** colours not listed are also available upon request
- **Non-RAL Program** colours have long lead times and could affect deliver date

CAYUGA STOCK COLOURS



Cayuga Black



Cayuga White

Cayuga black and white colours come in a textured finish.

Matte finish is available upon request.

RAL STOCK COLOURS



Traffic Blue
Ral 5017

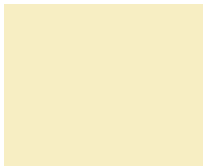

Cream
Ral 9001



Pure White
Ral 9010



Traffic Orange
Ral 2009



Pebble Grey
Ral 7032



Basalt Grey
Ral 7012



Traffic Grey
Ral 7042



Quartz Grey
Ral 7039



Traffic Red
Ral 3020

WOOD STAINS

CAYUGA STANDARD WOOD GRAINS



Oiled Cherry
Match to Pionite/Panolam
WC421 (Oiled Cherry)



Wild Cherry
Match to Formica 5904-43
(Wild Cherry)



Select Cherry
Match to Formica 7759
(Select Cherry)



Choco Cherry
Match to Panval/Uniboard
207 (Choco Cherry)



Natural Maple
Match to Formica 86992-58
(Hardrock Maple)



Pearwood
Match to Pionite/Panolam
WX031 (Pearwood)

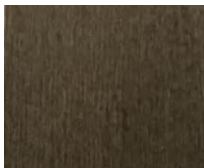

Weathered Wood
Match to Formica 8909-NF
(Cascara Teakwood)



Concerto
Match to Arborite T485/
Tafisa L485 (Concerto)

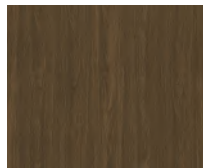

Danish Walnut
Match to Arborite W305
(Parliament Walnut)



Witchcraft
Match to Pionite/Panolam
WX421 (Witchcraft)



Iron Mountain
Match to Formica 912-58
(Storm)

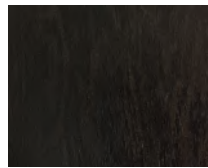

Baloil
Match to Formica 6414 NG
(Black Riftwood)

Refer to physical swatches for a true representation of colors, above images may appear slightly different than actual samples.

HOW TO ORDER

We'll help you select the right case for your requirements. The steps below will help us to serve you best.

- 1 Choose the showcase that meets your display requirements from the product specification sheets.
- 2 Review the options table found on the specification sheet and make your selections of the options provided.
- 3 Select from the large pallet of colours found on the last five pages of the brochure, or choose a stainless steel, standard black or white for the exterior finish of your showcase.
- 4 E-mail your request for a quote to your Cayuga sales representative or sales@cayugadisplays.com and we will quickly respond to your request. Please include your full contact information in case we have any questions.

Contact the inside sales team

Cayuga Displays

E: sales@cayugadisplays.com

T: 1-800-839-5536

F: 1-905-772-3179



T: 800.839.5536 F: 905.772.3179

E: sales@cayugadisplays.com

A: 88 Talbot St E, PO Box 130
Cayuga, ON N0A 1E0

